

# ООО Чугунторг

+7 (495) 989-83-31

+7 (495) 668-08-14

[www.chuguntorg.ru](http://www.chuguntorg.ru)

## КАТАЛОГ

# Фитинги чугунные ТИТАН

(Производство Словения)



@GIT

SIQ



ZAG

LJUBLJANA

DVGW

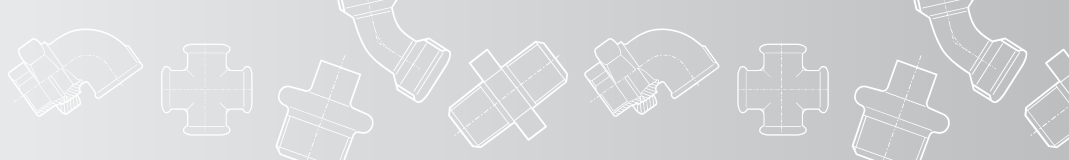

stran/page

1



ART.1 ISO G4      ART.2 ISO G1

2



ART.40 ISO G4/45°      ART.41 ISO G1/45°      ART.85

3



ART.90 ISO A1      ART.90R ISO A1

4



ART.92 ISO A4      ART.95 ISO UA1

5



ART.96 ISO UA11      ART.97 ISO UA2

6



ART.98 ISO UA12      ART.130 ISO B1

7



ART.130R ISO B1

8



ART.180 ISO C1      ART.240 ISO M2

9



ART.241 ISO N4

10



ART.245 ISO N8      ART.246 ISO M4

11



ART.270 ISO M2      ART.271 D/L ISO M2 R/L

12



ART.280 ISO N8      ART.281D/L ISO N8 R/L

13



ART.290 ISO T9      ART.300 ISO T1

14



ART.312 ISO P4      ART.321      ART.330 ISO U1

15



ART.331 ISO U7      ART.340 ISO U11

16



ART.341 ISO U12      ART.370

17



ART.371      ART.372

18



ART.374 ISO P1      ART.471

19



ART.529a ISO M4      ART.620      ART.621

20



ART.622      ART.372-374

21



ART.820      ART.822

22



ART.821      ART.900

23



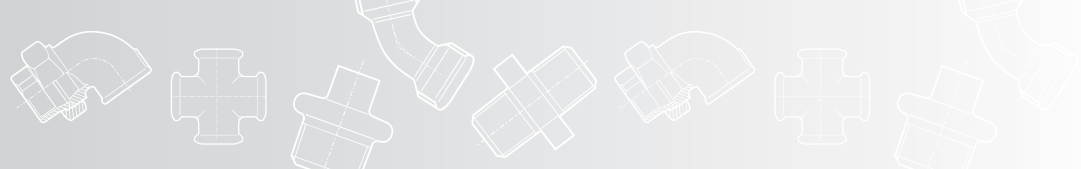

ART.800      ART.802



**ART.1**  
ISO G4





**LOK 90° Z/N NAVOJ**  
**LONG SWEEP BEND 90° M/F THREAD**  
**CURVA LUNGA 90° M/F FILETTATURA**  
**LANGER BOGEN 90° M/F GEWINDE**

Dim. mm	velikost	koda	a	b			
15	1/2"Č	KA10720103	55	48	170	10	0,110
15	1/2"P	KA10725103	55	48	170	10	0,116
20	3/4"Č	KA10720104	69	60	100	10	0,190
20	3/4"P	KA10725104	69	60	100	10	0,200
25	1"Č	KA10720105	85	75	40	10	0,310
25	1"P	KA10725105	85	75	40	10	0,326
32	1 1/4"Č	KA10720206	105	95	25		0,539
32	1 1/4"P	KA10725206	105	95	25		0,566
40	1 1/2"Č	KA10720207	116	105	18		0,772
40	1 1/2"P	KA10725207	116	105	18		0,811
50	2"Č	KA10720208	140	130	9		1,402
50	2"P	KA10725208	140	130	9		1,440
65	2 1/2"Č	KA10720209	176	165	4		2,620
65	2 1/2"P	KA10725209	176	165	4		2,700
80	3"Č	KA10720210	205	190	3		3,860
80	3"P	KA10725210	205	190	3		3,980

**ART.2**  
ISO G1



**LOK 90°**  
**LONG SWEEP BEND 90°**  
**CURVA LUNGA 90°**  
**LANGER BOGEN 90°**

Dim. mm	velikost	koda	a			
15	1/2"Č	KA10700103	55	140	10	0,142
15	1/2"P	KA10705103	55	140	10	0,149
20	3/4"Č	KA10700104	69	80	10	0,235
20	3/4"P	KA10705104	69	80	10	0,247
25	1"Č	KA10700105	85	40	10	0,368
25	1"P	KA10705105	85	40	10	0,386
32	1 1/4"Č	KA10700206	105	20		0,657
32	1 1/4"P	KA10705206	105	20		0,690
40	1 1/2"Č	KA10700207	116	15		0,850
40	1 1/2"P	KA10705207	116	15		0,893
50	2"Č	KA10700208	140	8		1,354
50	2"P	KA10705208	140	8		1,422
65	2 1/2"Č	KA10700209	176	4		3,060
65	2 1/2"P	KA10705209	176	4		3,150
80	3"Č	KA10700210	205	3		4,051
80	3"P	KA10705210	205	3		4,295

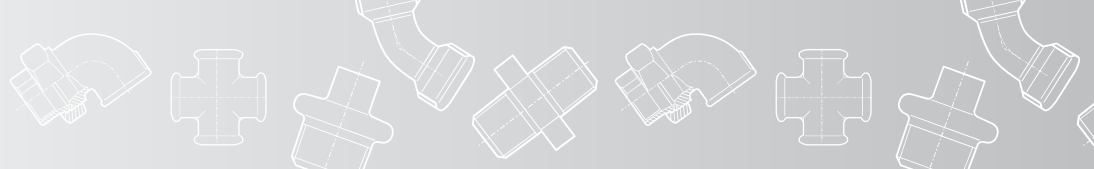

**ART.40**  
ISO G4/45°

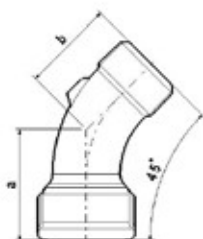



**LOK 45° Z/N NAVOJ**  
**LONG SWEEP BEND 45° M/F THREAD**  
**CURVA LUNGA 45° M/F FILETTATURA**  
**LANGER BOGEN 45° M/F GEWINDE**

Dim. mm	velikost	koda	a	b			
15	1/2"Č	KA10730103	22	28	180	10	0,105
15	1/2"P	KA10735103	22	28	180	10	0,108
20	3/4"Č	KA10730104	25	32	120	10	0,160
20	3/4"P	KA10735104	25	32	120	10	0,165
25	1"Č	KA10730105	28	37	70	10	0,252
25	1"P	KA10735105	28	37	70	10	0,260
32	1 1/4"Č	KA10730206	33	43	40		0,436
32	1 1/4"P	KA10735206	33	43	40		0,450
40	1 1/2"Č	KA10730207	36	46	30		0,552
40	1 1/2"P	KA10735207	36	46	30		0,572
50	2"Č	KA10730208	43	55	15		0,924
50	2"P	KA10735208	43	55	15		0,953

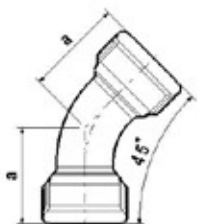
**ART.41**  
ISO G1/45°





**LOK 45°**  
**LONG SWEEP BEND 45°**  
**CURVA LUNGA 45°**  
**LANGER BOGEN 45°**

Dim. mm	velikost	koda	a			
15	1/2"Č	KA10770103	22	180	10	0,132
15	1/2"P	KA10775103	22	180	10	0,137
20	3/4"Č	KA10770104	25	110	10	0,192
20	3/4"P	KA10775104	25	110	10	0,198
25	1"Č	KA10770105	28	60	10	0,312
25	1"P	KA10775105	28	60	10	0,323
32	1 1/4"Č	KA10770206	33	35		0,512
32	1 1/4"P	KA10775206	33	35		0,528
40	1 1/2"Č	KA10770207	36	25		0,650
40	1 1/2"P	KA10775207	36	25		0,673
50	2"Č	KA10770208	43	15		1,080
50	2"P	KA10775208	43	15		1,120

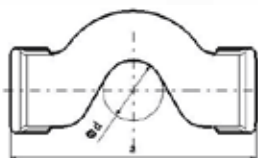
**ART.85**



**IZMIKALNI LOK**  
**CROSSOVER**  
**SCALVLCATUBA A CURVA**  
**ÜBERSPRINGBOGEN**

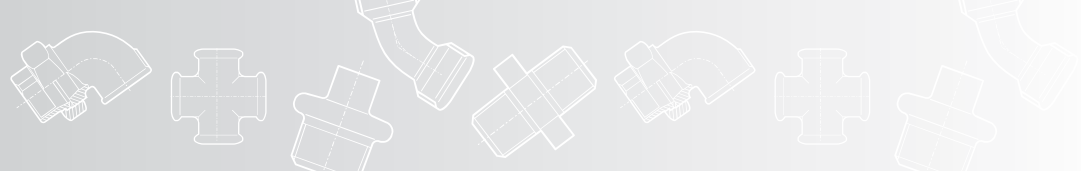

Dim. mm	velikost	koda	a	d			
15	1/2"Č	KA10760103	90	22	100	10	0,184
15	1/2"P	KA10765103	90	22	100	10	0,191
20	3/4"Č	KA10760104	110	28	50	10	0,271
20	3/4"P	KA10765104	110	28	50	10	0,285
25	1"Č	KA10760105	140	34	30	10	0,418
25	1"P	KA10765105	140	34	30	10	0,433

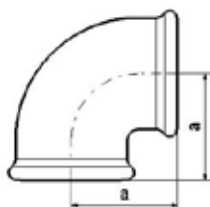

**ART.90**  
ISO A1





**KOLENO**  
**ELBOW**  
**GOMITO**  
**WINKEL**

Dim. mm	velikost	koda	a			
10	3/8"Č	KA10210102	25	350	25	0,070
10	3/8"P	KA10215102	25	350	25	0,074
15	1/2"Č	KA10210103	28	230	10	0,093
15	1/2"P	KA10215103	28	230	10	0,098
20	3/4"Č	KA10210104	33	130	10	0,147
20	3/4"P	KA10215104	33	130	10	0,154
25	1"Č	KA10210105	38	80	10	0,226
25	1"P	KA10215105	38	80	10	0,235
32	1 1/4"Č	KA10210206	45	50		0,333
32	1 1/4"P	KA10215206	45	50		0,350
40	1 1/2"Č	KA10210207	50	30		0,422
40	1 1/2"P	KA10215207	50	30		0,443
50	2"Č	KA10210208	58	20		0,727
50	2"P	KA10215208	58	20		0,750
65	2 1/2"Č	KA10210209	69	10		1,231
65	2 1/2"P	KA10215209	69	10		1,275
80	3"Č	KA10210210	78	6		1,490
80	3"P	KA10215210	78	6		1,543
100	4"Č	KA22210211	96	3		2,580
100	4"P	KA22215211	96	3		2,760

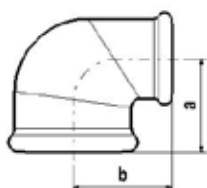
**ART.90R**  
ISO A1



**KOLENO -RED.**  
**ELBOW -RED.**  
**GOMITO -RID.**  
**WINKEL -RED.**

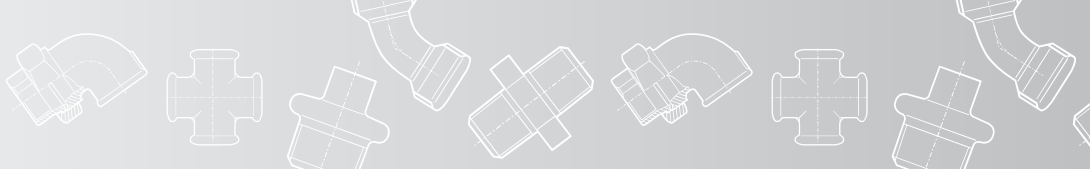

Dim. mm	velikost	koda	a	b			
20-15	3/4"-1/2"Č	KA10220105	30	31	150	10	0,125
20-15	3/4"-1/2"P	KA10225105	30	31	150	10	0,131
25-15	1"-1/2"Č	KA10220106	32	34	110	10	0,170
25-15	1"-1/2"P	KA10225106	32	34	110	10	0,176
25-20	1"-3/4"Č	KA10220107	35	36	100	10	0,198
25-20	1"-3/4"P	KA10225107	35	36	100	10	0,204
32-20	1 1/4"-3/4"Č	KA10220208	36	41	75		0,241
32-20	1 1/4"-3/4"P	KA10225208	36	41	75		0,250
32-25	1 1/4"-1"Č	KA10220209	40	42	70		0,294
32-25	1 1/4"-1"P	KA10225209	40	42	70		0,303
40-20	1 1/2"-3/4"Č	KA10220214	38	44	60		0,318
40-20	1 1/2"-3/4"P	KA10225214	38	44	60		0,328
40-25	1 1/2"-1"Č	KA10220215	42	46	45		0,373
40-25	1 1/2"-1"P	KA10225215	42	46	45		0,385
80-50	3"-2"Č	KA10220230	64	73	11		1,241
80-50	3"-2"P	KA10225230	64	73	11		1,286
80-65	3"-2 1/2"Č	KA10220231	72	73	9		1,451
80-65	3"-2 1/2"P	KA10225231	72	73	9		1,503

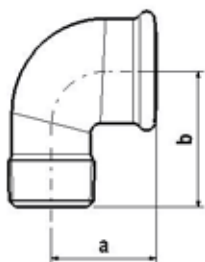

**ART.92**  
**ISO A4**

**KOLENO Z/N NAVOJ**  
**ELBOW M/F THREAD**  
**GOMITO M/F FILETTATURA**  
**WINKEL M/F GEWINDE**





Dim. mm	velikost	koda	a	b			
10	3/8"Č	KA10200101	25	32	400	25	0,063
10	3/8"P	KA10205101	25	32	400	25	0,066
15	1/2"Č	KA10200102	28	37	250	10	0,098
15	1/2"P	KA10205102	28	37	250	10	0,103
20	3/4"Č	KA10200103	33	43	150	10	0,146
20	3/4"P	KA10205103	33	43	150	10	0,153
25	1"Č	KA10200104	38	52	80	10	0,224
25	1"P	KA10205104	38	52	80	10	0,230
32	1 1/4"Č	KA10200205	45	60	45		0,354
32	1 1/4"P	KA10205205	45	60	45		0,372
40	1 1/2"Č	KA10200206	50	65	35		0,450
40	1 1/2"P	KA10205206	50	65	35		0,473
50	2"Č	KA10200207	58	74	16		0,740
50	2"P	KA10205207	58	74	16		0,777
65	2 1/2"Č	KA10200208	69	88	10		1,509
65	2 1/2"P	KA10205208	69	88	10		1,540
80	3"Č	KA10200209	78	98	6		2,265
80	3"P	KA10205209	78	98	6		2,312

**ART.95**  
**ISO UA1**

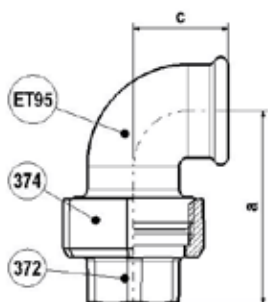
**KOLENO S PRIVIJALOM, PLOŠČATO TESNENJE**  
**UNION ELBOW, FLAT SEAT**  
**GOMITO CON BOCCHETONE A SEDE PIANA**  
**WINKELVERSCHRAUBUNG, FLACH DICHTEND**



Dim. mm	velikost	koda	a	c			
15	1/2"Č	KA10540102	58	28	90	10	0,268
15	1/2"P	KA10545102	58	28	90	10	0,279
20	3/4"Č	KA10540103	62	33	60	10	0,361
20	3/4"P	KA10545103	62	33	60	10	0,378
25	1"Č	KA10540104	72	38	40	10	0,480
25	1"P	KA10545104	72	38	40	10	0,512
32	1 1/4"Č	KA10540205	82	45	24		0,850
32	1 1/4"P	KA10545205	82	45	24		0,870
40	1 1/2"Č	KA10540206	90	50	19		1,000
40	1 1/2"P	KA10545206	90	50	19		1,037
50	2"Č	KA10540207	100	58	10		1,546
50	2"P	KA10545207	100	58	10		1,602



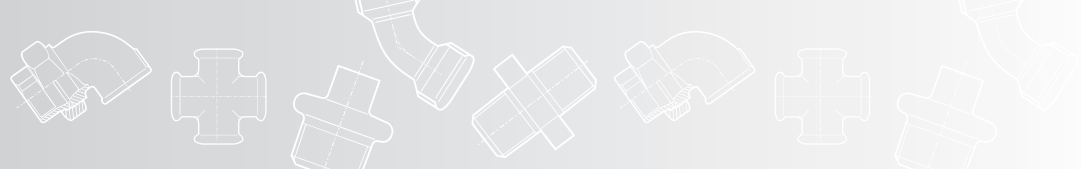

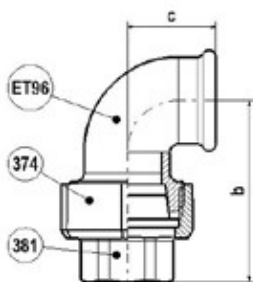

**ART.96**  
ISO UA11

**KOLENO S PRIVIJALOM, KONIČNO TESNENJE**  
**UNION ELBOW, TAPER SEAT**  
**GOMITO CON BOCCHETONE A SEDE CONICA**  
**WINKELVERSCHRAUBUNG MIT KEGELDICHTUNG**





Dim. mm	velikost	koda	b	c			
15	1/2"Č	KA10550102	58	28	90	10	0,288
15	1/2"P	KA10555102	58	28	90	10	0,300
20	3/4"Č	KA10550103	62	33	60	10	0,363
20	3/4"P	KA10555103	62	33	60	10	0,378
25	1"Č	KA10550104	72	38	40		0,473
25	1"P	KA10555104	72	38	40		0,510
32	1 1/4"Č	KA10550205	82	45	24		0,835
32	1 1/4"P	KA10555205	82	45	24		0,883
40	1 1/2"Č	KA10550206	90	50	19		0,976
40	1 1/2"P	KA10555206	90	50	19		1,015
50	2"Č	KA10550207	100	58	10		1,546
50	2"P	KA10555207	100	58	10		1,602

**ART.97**  
ISO UA2

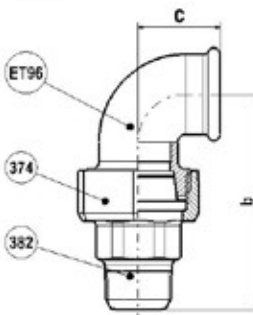
**KOLENO S PRIVIJALOM, PLOŠČATO TESNENJE Z/N NAVOJ**  
**UNION ELBOW, FLAT SEAT M/F THREAD**  
**GOMITO CON BOCCHETONE A SEDE PIANA M/F FILETTATURA**  
**WINKELVERSCHRAUBUNG, FLACH DICHTEND M/F GEWINDE**



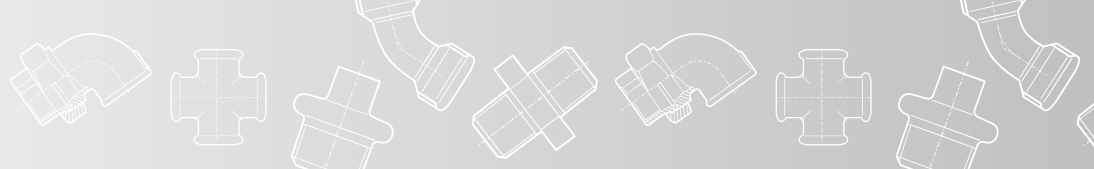

Dim. mm	velikost	koda	b	c			
15	1/2"Č	KA10560102	76	28	70	10	0,283
15	1/2"P	KA10565102	76	28	70	10	0,295
20	3/4"Č	KA10560103	82	33	50	10	0,399
20	3/4"P	KA10565103	82	33	50	10	0,414
25	1"Č	KA10560104	94	38	30	10	0,544
25	1"P	KA10565104	94	38	30	10	0,581
32	1 1/4"Č	KA10560205	107	45	20		0,940
32	1 1/4"P	KA10565205	107	45	20		0,970
40	1 1/2"Č	KA10560206	115	50	16		1,466
40	1 1/2"P	KA10565206	115	50	16		1,513
50	2"Č	KA10560207	128	58	8		1,813
50	2"P	KA10565207	128	58	8		1,855

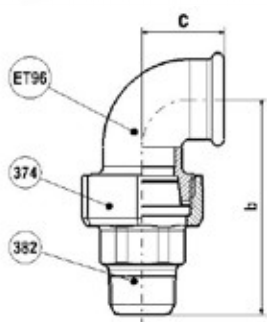

**ART.98**  
ISO UA12

KOLENO S PRIVIJALOM, KONIČNO TESNENJE Z/N NAVOJ  
UNION ELBOW, TAPER SEAT M/F THREAD  
GOMITO CON BOCCHETONE A SEDE CONICA M/F FILETTATURA  
WINKELVERSCHRAUBUNG MIT KEGELDICHTUNG M/F GEWINDE





Dim. mm	velikost	koda	b	c			
15	1/2"Č	KA10570102	76	28	70	10	0,310
15	1/2"P	KA10575102	76	28	70	10	0,323
20	3/4"Č	KA10570103	82	33	50	10	0,414
20	3/4"P	KA10575103	82	33	50	10	0,431
25	1"Č	KA10570104	94	38	30	10	0,593
25	1"P	KA10575104	94	38	30	10	0,597
32	1 1/4"Č	KA10570205	107	45	20		0,978
32	1 1/4"P	KA10575205	107	45	20		0,987
40	1 1/2"Č	KA10570206	115	50	16		1,456
40	1 1/2"P	KA10575206	115	50	16		1,478
50	2"Č	KA10570207	128	58	8		1,873
50	2"P	KA10575207	128	58	8		1,913

**ART.130**  
ISO B1

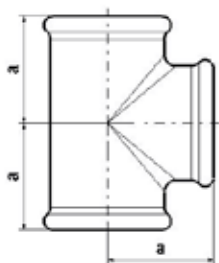
T KOS  
T PIECE  
TI  
T STÜCK



Dim. mm	velikost	koda	a			
10	3/8"Č	KA10100102	25	225	25	0,098
10	3/8"P	KA10105102	25	225	25	0,103
15	1/2"Č	KA10100103	28	140	10	0,132
15	1/2"P	KA10105103	28	140	10	0,139
20	3/4"Č	KA10100104	33	90	10	0,196
20	3/4"P	KA10105104	33	90	10	0,206
25	1"Č	KA10100105	38	50	10	0,294
25	1"P	KA10105105	38	50	10	0,309
32	1 1/4"Č	KA10100206	45	30		0,502
32	1 1/4"P	KA10105206	45	30		0,527
40	1 1/2"Č	KA10100207	50	28		0,605
40	1 1/2"P	KA10105207	50	28		0,635
50	2"Č	KA10100208	58	15		1,000
50	2"P	KA10105208	58	15		1,035
65	2 1/2"Č	KA10100209	69	8		1,580
65	2 1/2"P	KA10105209	69	8		1,640
80	3"Č	KA10100210	78	5		1,885
80	3"P	KA10105210	78	5		1,979
100	4"Č	KA22100211	96	3		3,513
100	4"P	KA22105211	96	3		3,660



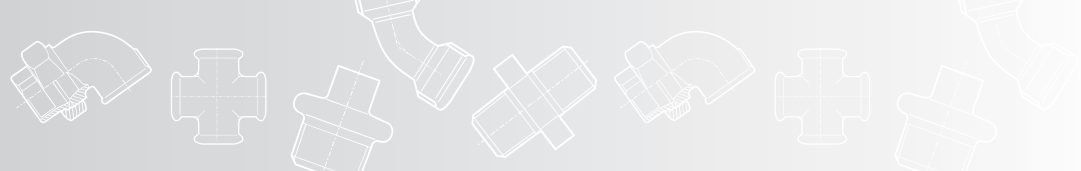

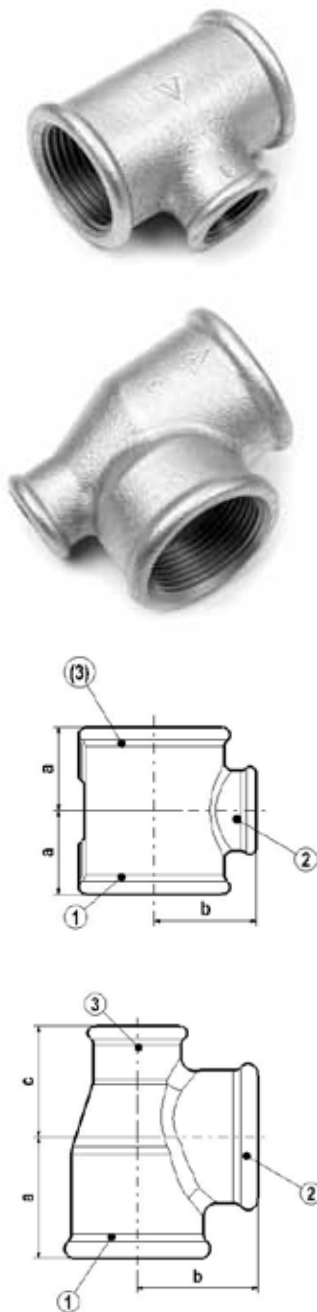

ART.130R  
ISO B1

T KOS RED.  
T PIECE RED.  
TI RID.  
T STÜCK RED.



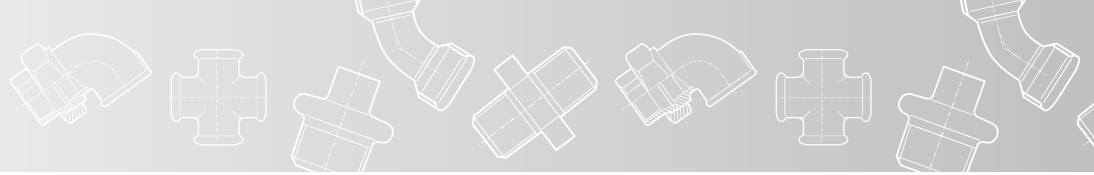

Dim. mm	velikost	koda	a	b	c			
20-15	3/4"-1/2"-3/4"Č	KA10110109	30	31	30	90	10	0,178
20-15	3/4"-1/2"-3/4"P	KA10115109	30	31	30	90	10	0,187
25-15	1"-1/2"-1"Č	KA10110114	32	34	32	60	10	0,239
25-15	1"-1/2"-1"P	KA10115114	32	34	32	60	10	0,251
25-20	1"-3/4"-1"Č	KA10110115	35	36	35	50	10	0,262
25-20	1"-3/4"-1"P	KA10115115	35	36	35	50	10	0,275
32-15	1 1/4"-1/2"-11/4"Č	KA10110219	36	41	36		55	0,333
32-15	1 1/4"-1/2"-11/4"P	KA10115219	36	41	36		55	0,347
32-20	1 1/4"-3/4"-11/4"Č	KA10110220	36	41	36		50	0,354
32-20	1 1/4"-3/4"-11/4"P	KA10115220	36	41	36		50	0,365
32-25	1 1/4"-1"-11/4"Č	KA10110221	40	42	40		35	0,412
32-25	1 1/4"-1"-11/4"P	KA10115221	40	42	40		35	0,433
40-15	1 1/2"-1/2"-11/2"Č	KA10110224	36	42	36		35	0,500
40-15	1 1/2"-1/2"-11/2"P	KA10115224	36	42	36		35	0,517
40-25	1 1/2"-1"-11/2"Č	KA10110226	42	46	42		25	0,478
40-25	1 1/2"-1"-11/2"P	KA10115226	42	46	42		25	0,502
50-15	2"-1/2"-2"Č	KA10110229	38	48	38		24	0,620
50-15	2"-1/2"-2"P	KA10115229	38	48	38		24	0,643
50-20	2"-3/4"-2"Č	KA10110230	40	50	40		24	0,640
50-20	2"-3/4"-2"P	KA10115230	40	50	40		24	0,670
50-25	2"-1"-2"Č	KA10110231	44	52	44		18	0,705
50-25	2"-1"-2"P	KA10115231	44	52	44		18	0,725
50-32	2"-11/4"-2"Č	KA10110232	48	54	48		20	0,820
50-32	2"-11/4"-2"P	KA10115232	48	54	48		20	0,845
50-40	2"-11/2"-2"Č	KA10110233	52	55	52		18	0,880
50-40	2"-11/2"-2"P	KA10115233	52	55	52		18	0,916
80-65	3"-21/2"-3"Č	KA10110242	72	76	72		6	1,930
80-65	3"-21/2"-3"P	KA10115242	72	76	72		6	1,990
32-40-32	1 1/4"-11/2"-1 1/4"Č	KA10110250	48	46	48		28	0,615
32-40-32	1 1/4"-11/2"-1 1/4"P	KA10115250	48	46	48		28	0,63
80-50-80	3"-2"-3"P	KA10115241	64	73	64		6	1,720
80-50-80	3"-2"-3"Č	KA10110241	64	73	64		6	1,663
20-20-15	3/4"-3/4"-1/2"Č	KA10110170	33	33	31	90	10	0,190
20-20-15	3/4"-3/4"-1/2"P	KA10115170	33	33	31	90	10	0,208
25-25-15	1"-1"-1/2"Č	KA10110159	38	38	34	50	10	0,263
25-25-15	1"-1"-1/2"P	KA10115159	38	38	34	50	10	0,288
25-25-20	1"-1"-3/4"Č	KA10110160	38	38	36	50	10	0,278
25-25-20	1"-1"-3/4"P	KA10115160	38	38	36	50	10	0,286
32-32-15	1 1/4"-11/4"-1/2"Č	KA10110263	45	45	38		35	0,400
32-32-15	1 1/4"-11/4"-1/2"P	KA10115263	45	45	38		35	0,420
32-32-20	1 1/4"-11/4"-3/4"Č	KA10110264	45	45	41		35	0,440
32-32-20	1 1/4"-11/4"-3/4"P	KA10115264	45	45	41		35	0,460
32-32-25	1 1/4"-11/4"-1"Č	KA10110265	45	45	42		35	0,432
32-32-25	1 1/4"-11/4"-1"P	KA10115265	45	45	42		35	0,445
20-15-15	3/4"-1/2"-1/2"Č	KA10110148	30	31	28	120	10	0,158
20-15-15	3/4"-1/2"-1/2"P	KA10115148	30	31	28	120	10	0,166

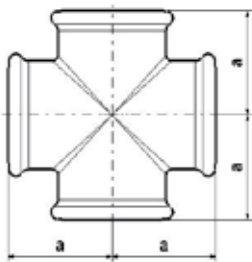

**ART.180**  
ISO C1





**KRIŽNI KOS**  
CROSSE  
CROCE  
KREUZ

Dim. mm	velikost	koda	a			
15	1/2"Č	KA10150103	28	110	10	0,182
15	1/2"P	KA10155103	28	110	10	0,191
20	3/4"Č	KA10150104	33	70	10	0,257
20	3/4"P	KA10155104	33	70	10	0,270
25	1"Č	KA10150105	38	30	10	0,363
25	1"P	KA10155105	38	30	10	0,381
32	1 1/4"Č	KA10150206	45	23		0,540
32	1 1/4"P	KA10155206	45	23		0,567
40	1 1/2"Č	KA10150207	50	15		0,730
40	1 1/2"P	KA10155207	50	15		0,758
50	2"Č	KA10150208	58	10		1,148
50	2"P	KA10155208	58	10		1,178

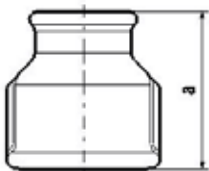
**ART.240**  
ISO M2



**OBJEMKA RED.**  
SOCKET RED.  
MANICOTTO RID.  
MUFFE RED.

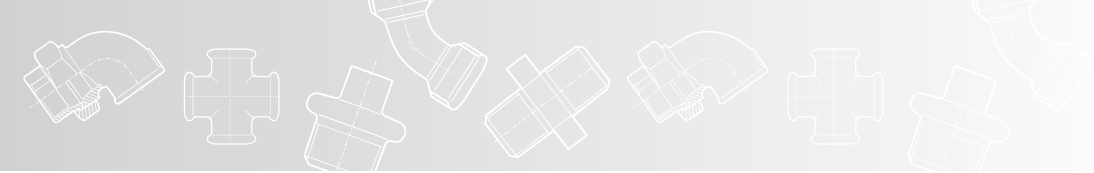

Dim. mm	velikost	koda	a			
15-10	1/2"-3/8"Č	KA10320103	36	280	10	0,076
15-10	1/2"-3/8"P	KA10325103	36	280	10	0,078
20-15	3/4"-1/2"Č	KA10320106	39	220	10	0,103
20-15	3/4"-1/2"P	KA10325106	39	220	10	0,107
25-15	1"-1/2"Č	KA10320108	45	130	10	0,165
25-15	1"-1/2"P	KA10325108	45	130	10	0,170
25-20	1"-3/4"Č	KA10320110	45	130	10	0,156
25-20	1"-3/4"P	KA10325110	45	130	10	0,162
32-25	1 1/4"-1"Č	KA10320215	50		90	0,243
32-25	1 1/4"-1"P	KA10325215	50		90	0,250
40-20	1 1/2"-3/4"Č	KA10320219	55		70	0,294
40-20	1 1/2"-3/4"P	KA10325219	55		70	0,306
40-25	1 1/2"-1"Č	KA10320220	55		70	0,285
40-25	1 1/2"-1"P	KA10325220	55		70	0,293
40-32	1 1/2"-1 1/4"Č	KA10320221	55		60	0,307
40-32	1 1/2"-1 1/4"P	KA10325221	55		60	0,316
50-25	2"-1"Č	KA10320226	65		38	0,472
50-25	2"-1"P	KA10325226	65		38	0,487
50-40	2"-1 1/2"Č	KA10320228	65		35	0,475
50-40	2"-1 1/2"P	KA10325228	65		35	0,491

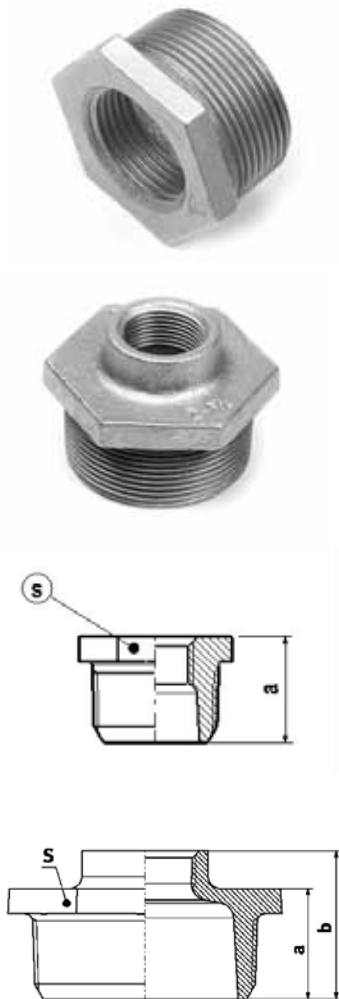

ART.241  
ISO N4

ZMANJŠEVALNI KOS  
REDUCING BUSH  
NIPPLO DI RIDUZIONE  
REDUZIERNIPPEL



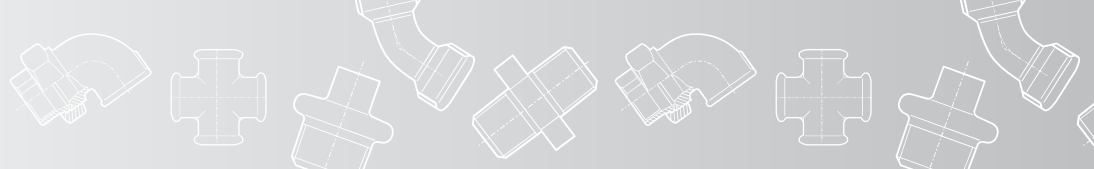

Dim. mm	velikost	koda	a	b	s			
15-10	1/2"-3/8"Č	KA10490103	24		22	700	10	0,025
15-10	1/2"-3/8"P	KA10495103	24		22	700	10	0,026
20-15	3/4"-1/2"Č	KA10490106	26		30	330	10	0,048
20-15	3/4"-1/2"P	KA10495106	26		30	330	10	0,050
25-20	1"-3/4"Č	KA10490110	29		36	220	10	0,078
25-20	1"-3/4"P	KA10495110	29		36	220	10	0,082
32-25	1 1/4"-1"Č	KA10490215	31		46	170		0,137
32-25	1 1/4"-1"P	KA10495215	31		46	170		0,144
40-32	1 1/2"-1 1/4"Č	KA10490221	31		50	130		0,121
40-32	1 1/2"-1 1/4"P	KA10495221	31		50	130		0,127
20-10	3/4"-3/8"Č	KA10490105	26		30	330	10	0,058
20-10	3/4"-3/8"P	KA10495105	26		30	330	10	0,061
25-15	1"-1/2"Č	KA10490109	29		36	220	10	0,095
25-15	1"-1/2"P	KA10495109	29		36	220	10	0,100
32-15	1 1/4"-1/2"Č	KA10490213	31		46	150		0,191
32-15	1 1/4"-1/2"P	KA10495213	31		46	150		0,201
32-20	1 1/4"-3/4"Č	KA10490214	31		46	150		0,175
32-20	1 1/4"-3/4"P	KA10495214	31		46	150		0,184
40-15	1 1/2"-1/2"Č	KA10490218	31		50	120		0,240
40-15	1 1/2"-1/2"P	KA10495218	31		50	120		0,252
40-20	1 1/2"-3/4"Č	KA10490219	31		50	120		0,236
40-20	1 1/2"-3/4"P	KA10495219	31		50	120		0,248
40-25	1 1/2"-1"Č	KA10490220	31		50	120		0,202
40-25	1 1/2"-1"P	KA10495220	31		50	120		0,212
50-25	2"-1"Č	KA10490226	35		65	60		0,427
50-25	2"-1"P	KA10495226	35		65	60		0,448
50-32	2"-1 1/4"Č	KA10490227	35		65	60		0,330
50-32	2"-1 1/4"P	KA10495227	35		65	60		0,347
50-40	2"-1 1/2"Č	KA10490228	35		65	70		0,295
50-40	2"-1 1/2"P	KA10495228	35		65	70		0,310
65-40	2 1/2"-1 1/2"Č	KA10490234	40		80	40		0,615
65-40	2 1/2"-1 1/2"P	KA10495234	40		80	40		0,646
65-50	2 1/2"-2"Č	KA10490235	40		80	40		0,483
65-50	2 1/2"-2"P	KA10495235	40		80	40		0,507
80-50	3"-2"Č	KA10490239	44		95	24		0,800
80-50	3"-2"P	KA10495239	44		95	24		0,840
80-65	3"-2 1/2"Č	KA10490240	44		95	25		0,650
80-65	3"-2 1/2"P	KA10495240	44		95	25		0,683
100-80	4"-3"Č	KA22490247	57		120	12		1,750
100-80	4"-3"P	KA22495247	57		120	12		1,800
50-15	2"-1/2"Č	KA10490224	35	48	65	50		0,338
50-15	2"-1/2"P	KA10495224	35	48	65	50		0,355
50-20	2"-3/4"Č	KA10490225	35	48	65	50		0,350
50-20	2"-3/4"P	KA10495225	35	48	65	50		0,368
65-25	2 1/2"-1"Č	KA10490232	40	54	80	30		0,562
65-25	2 1/2"-1"P	KA10495232	40	54	80	30		0,590
65-32	2 1/2"-1 1/4"Č	KA10490233	40	54	80	30		0,610
65-32	2 1/2"-1 1/4"P	KA10495233	40	54	80	30		0,641
80-32	3"-1 1/4"Č	KA10490237	44	59	95	20		0,880
80-32	3"-1 1/4"P	KA10495237	44	59	95	20		0,924
80-40	3"-1 1/2"Č	KA10490238	44	59	95	20		0,870
80-40	3"-1 1/2"P	KA10495238	44	59	95	20		0,914
100-50	4"-2"Č	KA22490245	57	69	120	12		1,750
100-50	4"-2"P	KA22495245	57	69	120	12		1,800

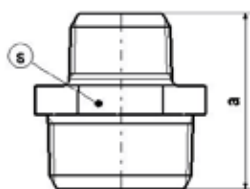

**ART.245**  
**ISO N8**





**DVOJNA SPOJKA RED.**  
**HEXAGON NIPPLE RED.**  
**NIPPLO DOPIO RID.**  
**DOPPELNIPPEL RED.**

Dim. mm	velikost	koda	a	s			
15-10	1/2"-3/8"Č	KA10480103	44	22	350	10	0,054
15-10	1/2"-3/8"P	KA10485103	44	22	350	10	0,056
20-15	3/4"-1/2"Č	KA10480105	47	30	230	10	0,095
20-15	3/4"-1/2"P	KA10485105	47	30	230	10	0,098
25-15	1"-1/2"Č	KA10480106	53	36	160	10	0,148
25-15	1"-1/2"P	KA10485106	53	36	160	10	0,155
25-20	1"-3/4"Č	KA10480107	53	36	150	10	0,146
25-20	1"-3/4"P	KA10485107	53	36	150	10	0,151
32-25	1 1/4"-1"Č	KA10480210	57	46	100		0,238
32-25	1 1/4"-1"P	KA10485210	57	46	100		0,245
40-25	1 1/2"-1"Č	KA10480211	59	50	80		0,260
40-25	1 1/2"-1"P	KA10485211	59	50	80		0,268
40-32	1 1/2"-1 1/4"Č	KA10480212	59	50	75		0,295
40-32	1 1/2"-1 1/4"P	KA10485212	59	50	75		0,300
50-25	2"-1"Č	KA10480214	68	65	45		0,436
50-25	2"-1"P	KA10485214	68	65	45		0,450
50-40	2"-1 1/2"Č	KA10480215	68	65	40		0,456
50-40	2"-1 1/2"P	KA10485215	68	65	40		0,470

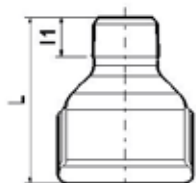
**ART.246**  
**ISO M4**



**OBJEMKA RED. Z/N NAVOJ**  
**SOCKET RED. M/F THREAD**  
**MANICOTTO RID. M/F FILETTATURA**  
**MUFFE RED. M/F GEWINDE**

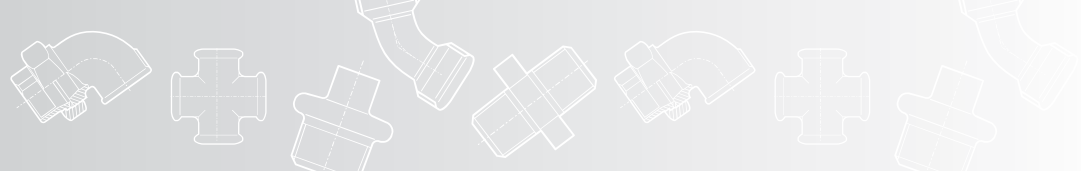

Dim. mm	velikost	koda	L	L1			
15-10	1/2"-3/8"Č	KA10350103	43	30	300	10	0,070
15-10	1/2"-3/8"P	KA10355103	43	30	300	10	0,072
20-15	3/4"-1/2"Č	KA10350106	48	33	200	10	0,102
20-15	3/4"-1/2"P	KA10355106	48	33	200	10	0,107
25-15	1"-1/2"Č	KA10350108	55	38	140	10	0,145
25-15	1"-1/2"P	KA10355108	55	38	140	10	0,149
25-20	1"-3/4"Č	KA10350110	55	38	120	10	0,156
25-20	1"-3/4"P	KA10355110	55	38	120	10	0,163
32-25	1 1/4"-1"Č	KA10350215	60	41		90	0,222
32-25	1 1/4"-1"P	KA10355215	60	41		90	0,232
40-25	1 1/2"-1"Č	KA10350220	63	44		70	0,272
40-25	1 1/2"-1"P	KA10355220	63	44		70	0,281
40-32	1 1/2"-1 1/4"Č	KA10350221	63	44		60	0,298
40-32	1 1/2"-1 1/4"P	KA10355221	63	44		60	0,312
50-25	2"-1"Č	KA10350226	70	46		45	0,413
50-25	2"-1"P	KA10355226	70	46		45	0,430
50-32	2"-1 1/4"Č	KA10350227	70	46		35	0,421
50-32	2"-1 1/4"P	KA10355227	70	46		35	0,439
50-40	2"-1 1/2"Č	KA10350228	70	46		35	0,444
50-40	2"-1 1/2"P	KA10355228	70	46		35	0,463

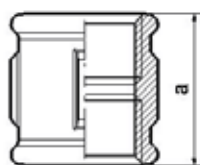

**ART.270**  
ISO M2





**OBJEMKA**  
**SOCKET**  
**MANICOTTO**  
**MUFFE**

Dim. mm	velikost	koda	a			
10	3/8"Č	KA10300102	30	450	25	0,054
10	3/8"P	KA10305102	30	450	25	0,057
15	1/2"Č	KA10300103	36	300	10	0,077
15	1/2"P	KA10305103	36	300	10	0,081
20	3/4"Č	KA10300104	39	190	10	0,110
20	3/4"P	KA10305104	39	190	10	0,116
25	1"Č	KA10300105	45	120	10	0,163
25	1"P	KA10305105	45	120	10	0,171
32	1 1/4"Č	KA10300206	50	80		0,248
32	1 1/4"P	KA10305206	50	80		0,260
40	1 1/2"Č	KA10300207	55	55		0,290
40	1 1/2"P	KA10305207	55	55		0,305
50	2"Č	KA10300208	65	30		0,488
50	2"P	KA10305208	65	30		0,512
65	2 1/2"Č	KA10300209	74	16		0,676
65	2 1/2"P	KA10305209	74	16		0,710
80	3"Č	KA10300210	80	14		0,960
80	3"P	KA10305210	80	14		1,008
100	4"Č	KA22300211	94	9		1,600
100	4"P	KA22305211	94	9		1,650

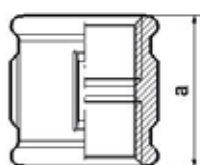
**ART.271 D/L**  
ISO M2 R/L



**OBJEMKA Z DESNIM IN LEVIM NAVOJEM**  
**SOCKET - RIGHT AND LEFT THREAD**  
**MANICOTTO CON FILETTATURA DESTRA / SINISTRA**  
**MUFFE MIT RECHTS UND LINKSGEWINDE**

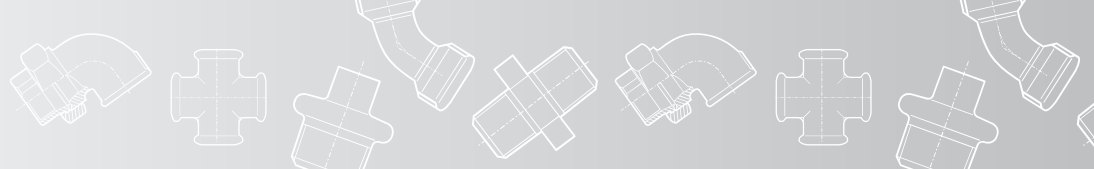

Dim. mm	velikost	koda	a			
15	1/2"Č	KA10310103	36	300	10	0,077
15	1/2"P	KA10315103	36	300	10	0,081
20	3/4"Č	KA10310104	39	190	10	0,110
20	3/4"P	KA10315104	39	190	10	0,116
25	1"Č	KA10310105	45	120	10	0,163
25	1"P	KA10315105	45	120	10	0,171
32	1 1/4"Č	KA10310206	50	80		0,248
32	1 1/4"P	KA10315206	50	80		0,260
40	1 1/2"Č	KA10310207	55	55		0,290
40	1 1/2"P	KA10315207	55	55		0,305
50	2"Č	KA10310208	65	30		0,488
50	2"P	KA10315208	65	30		0,512

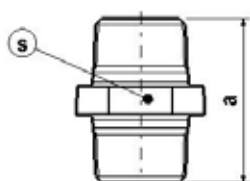

**ART.280**  
ISO N8





**DVOJNA SPOJKA**  
**HEXAGON NIPPLE**  
**NIPPLO DOPIO**  
**DOPPELNIPPEL**

Dim. mm	velikost	koda	a	s			
10	3/8"Č	KA10470102	38	22	550	25	0,045
10	3/8"P	KA10475102	38	22	550	25	0,047
15	1/2"Č	KA10470103	44	27	330	10	0,070
15	1/2"P	KA10475103	44	27	330	10	0,074
20	3/4"Č	KA10470104	47	32	190		0,103
20	3/4"P	KA10475104	47	32	190		0,108
25	1"Č	KA10470105	53	41	120		0,161
25	1"P	KA10475105	53	41	120		0,168
32	1 1/4"Č	KA10470206	57	50	80		0,281
32	1 1/4"P	KA10475206	57	50	80		0,290
40	1 1/2"Č	KA10470207	59	55	60		0,282
40	1 1/2"P	KA10475207	59	55	60		0,296
50	2"Č	KA10470208	68	70	30		0,442
50	2"P	KA10475208	68	70	30		0,464
65	2 1/2"Č	KA10470209	75	85	16		0,656
65	2 1/2"P	KA10475209	75	85	16		0,689
80	3"Č	KA10470210	83	100	12		0,872
80	3"P	KA10475210	83	100	12		0,916
100	4"Č	KA22470211	95	130	6		1,396
100			95	130	6		1,438

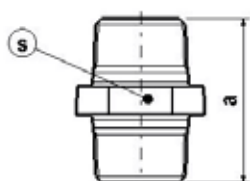
**ART.281 D/L**  
ISO N8 R/L



**DVOJNA SPOJKA Z DESNIM IN LEVIM NAVOJEM**  
**HEXAGON NIPPLE - RIGHT AND LEFT THREAD**  
**NIPPLO DOPIO CON FILETTATURA DESTRA / SINISTRA**  
**DOPPELNIPPEL MIT RECHTS UND LINKSGEWINDE**

Dim. mm	velikost	koda	a	s			
15	1/2"Č	KA10380103	44	27	330	10	0,070
15	1/2"P	KA10385103	44	27	330	10	0,074
20	3/4"Č	KA10380104	47	32	190	10	0,103
20	3/4"P	KA10385104	47	32	190	10	0,108
25	1"Č	KA10380105	53	41	120	10	0,165
25	1"P	KA10385105	53	41	120	10	0,173
32	1 1/4"Č	KA10380206	57	50	80		0,273
32	1 1/4"P	KA10385206	57	50	80		0,287
40	1 1/2"Č	KA10380207	59	55	60		0,282
40	1 1/2"P	KA10385207	59	55	60		0,296
50	2"Č	KA10380208	68	70	30		0,442
50	2"P	KA10385208	68	70	30		0,464



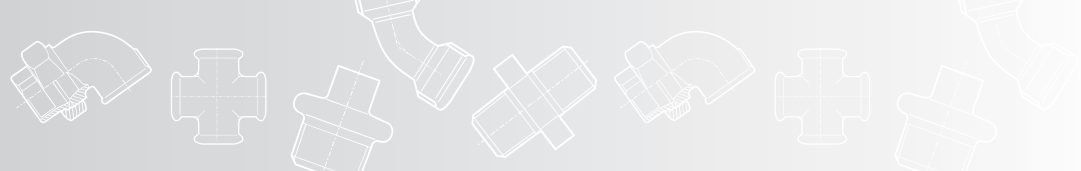

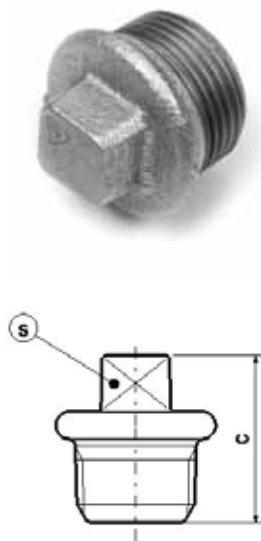

**ART.290**  
ISO T9





**ČEP**  
**PLUG, BEADED**  
**TAPPO CON BORDO**  
**STOPFEN MIT RAND**

Dim. mm	velikost	koda	a	s			
10	3/8"Č	KA10400102	24	10	1000	25	0,034
10	3/8"P	KA10405102	24	10	1000	25	0,036
15	1/2"Č	KA10400103	26	11	600	10	0,053
15	1/2"P	KA10405103	26	11	600	10	0,055
20	3/4"Č	KA10400104	32	17	300	10	0,086
20	3/4"P	KA10405104	32	17	300	10	0,090
25	1"Č	KA10400105	36	19	200	10	0,132
25	1"P	KA10405105	36	19	200	10	0,139
32	1 1/4"Č	KA10400206	39	22	140		0,206
32	1 1/4"P	KA10405206	39	22	140		0,216
40	1 1/2"Č	KA10400207	41	22	100		0,257
40	1 1/2"P	KA10405207	41	22	100		0,270
50	2"Č	KA10400208	48	27	65		0,371
50	2"P	KA10405208	48	27	65		0,390
65	2 1/2"Č	KA10400209	54	32	40		0,638
65	2 1/2"P	KA10405209	54	32	40		0,670
80	3"Č	KA10400210	60	36	25		0,926
80	3"P	KA10405210	60	36	25		0,972

**ART.300**  
ISO T1



**KAPA**  
**CAP**  
**CALLOTTA**  
**KAPPE**

Dim. mm	velikost	koda	a	s			
15	1/2"Č	KA10390103	19	26	500	10	0,051
15	1/2"P	KA10395103	19	26	500	10	0,053
20	3/4"Č	KA10390104	22	32	330	10	0,073
20	3/4"P	KA10395104	22	32	330	10	0,076
25	1"Č	KA10390105	24	39	200	10	0,140
25	1"P	KA10395105	24	39	200	10	0,145
32	1 1/4"Č	KA10390206	27	48	140		0,208
32	1 1/4"P	KA10395206	27	48	140		0,215
40	1 1/2"Č	KA10390207	27	54	110		0,233
40	1 1/2"P	KA10395207	27	54	110		0,240
50	2"Č	KA10390208	32	66	55		0,476
50	2"P	KA10395208	32	66	55		0,493
65	2 1/2"Č	KA10390209	41	85	30		0,739
65	2 1/2"P	KA10395209	41	85	30		0,762
80	3"Č	KA10390210	44	95	25		0,834
80	3"P	KA10395210	44	95	25		0,860
100	4"Č	KA10390211	46	130	10		1,930
100	4"P	KA10395211	46	130	10		2,020

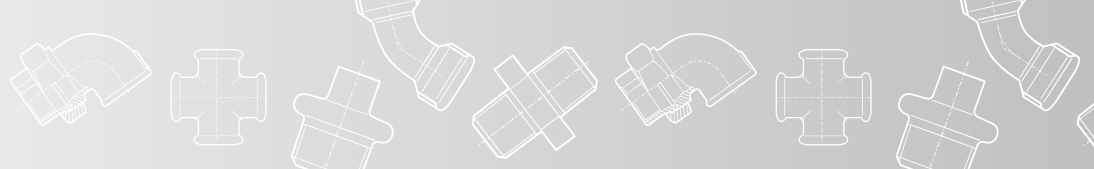

**ART.312**  
ISO P4





**PROTIMATICA**  
**BACKNUT, RECESSED**  
**CONTODADO CON SCANALATURA**  
**GEGENMUTER MIT AUSSPARUNG**

Dim. mm	velikost	koda	a	s			
15	1/2"Č	KA10830117	8	32	800	10	0,029
15	1/2"P	KA10835117	8	32	800	10	0,030
20	3/4"Č	KA10830118	10	36	550	10	0,043
20	3/4"P	KA10835118	10	36	550	10	0,045
25	1"Č	KA10830119	11	46	340	10	0,080
25	1"P	KA10835119	11	46	340	10	0,084
32	1 1/4"Č	KA10830220	13	55	200		0,120
32	1 1/4"P	KA10835220	13	55	200		0,126
40	1 1/2"Č	KA10830221	13	60	180		0,130
40	1 1/2"P	KA10835221	13	60	180		0,137
50	2"Č	KA10830222	14	75	100		0,214
50	2"P	KA10835222	14	75	100		0,225

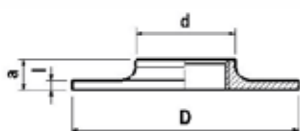
**ART.321**





**PRIROBNICA**  
**FLANGES**  
**FLANGES**  
**FLANSCH**

Dim. mm	velikost	koda	a	d	D	l			
50	2"Č	KA10800208	22	71	160	7	20		1,111
50	2"P	KA10805208	22	71	160	7	20		1,145

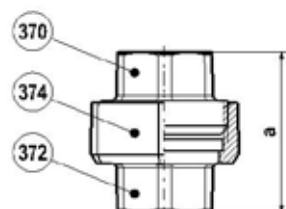
**ART.330**  
ISO U1



**PRIVIJALO, PLOŠČATO TESNENJE**  
**UNION, FLAT SEAT**  
**BOCCHETTONE A SEDE PIANA**  
**VERSCHRAUBUNG MIT FLACH DICHTEND**

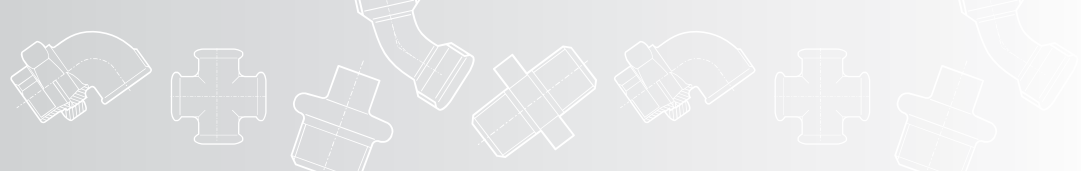

Dim. mm	velikost	koda	a			
15	1/2"Č	KA10500103	48	110	10	0,245
15	1/2"P	KA10505103	48	110	10	0,257
20	3/4"Č	KA10500104	52	90	10	0,275
20	3/4"P	KA10505104	52	90	10	0,289
25	1"Č	KA10500105	58	60	10	0,327
25	1"P	KA10505105	58	60	10	0,341
32	1 1/4"Č	KA10500206	65	35		0,617
32	1 1/4"P	KA10505206	65	35		0,648
40	1 1/2"Č	KA10500207	70	25		0,770
40	1 1/2"P	KA10505207	70	25		0,809
50	2"Č	KA10500208	78	15		1,120
50	2"P	KA10505208	78	15		1,176
65	2 1/2"Č	KA10500209	85	12		1,879
65	2 1/2"P	KA10505209	85	12		1,937
80	3"Č	KA10500210	95	6		2,850
80	3"P	KA10505210	95	6		3,000

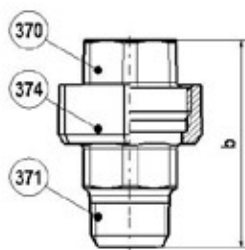

**ART.331**  
ISO U2





**PRIVIJALO, PLOŠČATO TESNENJE Z/N NAVOJ**  
**UNION, FLAT SEAT M/F THREAD**  
**BOCCHETTONE A SEDE PIANA M/F FILETTATURA**  
**VERSCHRAUBUNG MIT FLACH DICHTEND M/F GEWINDE**

Dim. mm	velikost	koda	b			
15	1/2"Č	KA10520102	66	90	10	0,256
15	1/2"P	KA10525102	66	90	10	0,269
20	3/4"Č	KA10520103	72	70	10	0,320
20	3/4"P	KA10525103	72	70	10	0,336
25	1"Č	KA10520104	80	50	10	0,403
25	1"P	KA10525104	80	50	10	0,418
32	1 1/4"Č	KA10520205	90	30		0,700
32	1 1/4"P	KA10525205	90	30		0,735
40	1 1/2"Č	KA10520206	95	21		0,800
40	1 1/2"P	KA10525206	95	21		0,830
50	2"Č	KA10520207	106	13		1,250
50	2"P	KA10525207	106	13		1,280
65	2 1/2"Č	KA10520208	118	8		2,260
65	2 1/2"P	KA10525208	118	8		2,330
80	3"Č	KA10520209	130	5		3,070
80	3"P	KA10525209	130	5		3,170

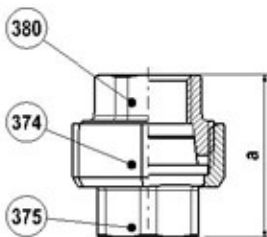
**ART.340**  
ISO U11



**PRIVIJALO, KONIČNO TESNENJE**  
**UNION, TAPER SEAT**  
**BOCCHETTONE A SEDE CONICA**  
**VERSCHRAUBUNG MIT KEGELDICHTUNG**

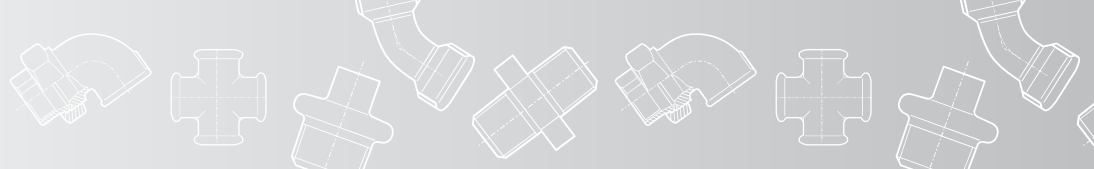

Dim. mm	velikost	koda	a			
15	1/2"Č	KA10510103	48	110	10	0,255
15	1/2"P	KA10515103	48	110	10	0,268
20	3/4"Č	KA10510104	52	90	10	0,290
20	3/4"P	KA10515104	52	90	10	0,305
25	1"Č	KA10510105	58	60	10	0,347
25	1"P	KA10515105	58	60	10	0,356
32	1 1/4"Č	KA10510206	65	35		0,620
32	1 1/4"P	KA10515206	65	35		0,651
40	1 1/2"Č	KA10510207	70	25		0,720
40	1 1/2"P	KA10515207	70	25		0,756
50	2"Č	KA10510208	78	15		1,200
50	2"P	KA10515208	78	15		1,260
65	2 1/2"Č	KA10510209	85	12		2,060
65	2 1/2"P	KA10515209	85	12		2,136
80	3"Č	KA10510210	95	6		2,490
80	3"P	KA10515210	95	6		2,594

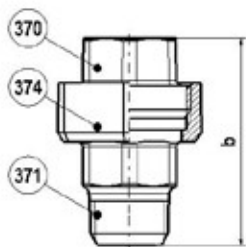

**ART.341**  
ISO U12

**PRIVIJALO, KONIČNO TESNENJE Z/N NAVOJ**  
**UNION, TAPER SEAT M/F THREAD**  
**BOCCHETTONE A SEDE CONICA M/F FILETTATURA**  
**VERSCHRAUBUNG MIT KEGELDICHTUNG M/F GEWINDE**





Dim. mm	velikost	koda	b			
15	1/2"Č	KA10530102	66	90	10	0,260
15	1/2"P	KA10535102	66	90	10	0,273
20	3/4"Č	KA10530103	72	70	10	0,320
20	3/4"P	KA10535103	72	70	10	0,336
25	1"Č	KA10530104	80	50	10	0,410
25	1"P	KA10535104	80	50	10	0,430
32	1 1/4"Č	KA10530205	90	30		0,775
32	1 1/4"P	KA10535205	90	30		0,790
40	1 1/2"Č	KA10530206	95	21		0,890
40	1 1/2"P	KA10535206	95	21		0,900
50	2"Č	KA10530207	106	13		1,281
50	2"P	KA10535207	106	13		1,316
65	2 1/2"Č	KA10530208	118	8		2,375
65	2 1/2"P	KA10535208	118	8		2,460
80	3"Č	KA10530209	130	5		3,074
80	3"P	KA10535209	130	5		3,170

**ART.370**

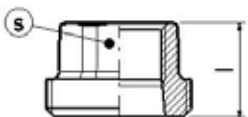
**UVIJAČNI DEL, PLOŠČATO TESNENJE**  
**UNION BUSH, FLAT SEAT**  
**PEZZO FILETTATO, SEDE PIANA**  
**ENISHRAUBTEILE, FLACH DICHTEND**



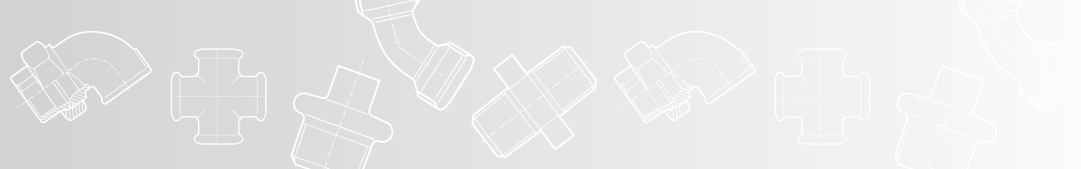

Dim. mm	velikost	koda	l	s			
15	1/2"Č	KA12930003	24,5	27	380	10	0,075
15	1/2"P	KA12935003	24,5	27	380	10	0,079
20	3/4"Č	KA12930004	26,5	32	320	10	0,083
20	3/4"P	KA12935004	26,5	32	320	10	0,087
25	1"Č	KA12930005	29,0	38	200	10	0,116
25	1"P	KA12935005	29,0	38	200	10	0,122
32	1 1/4"Č	KA12930006	33,0	47	115		0,165
32	1 1/4"P	KA12935006	33,0	47	115		0,173
40	1 1/2"Č	KA12930007	36,0	53	70		0,280
40	1 1/2"P	KA12935007	36,0	53	70		0,294
50	2"Č	KA12930008	40,0	66	40		0,440
50	2"P	KA12935008	40,0	66	40		0,462

**ART.371**

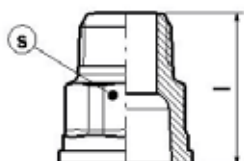
VLOŽNI DEL, PLOŠČATO TESNENJE /Z NAVOJ  
 UNION END, FLAT SEAT /M THREAD  
 PEZZO FOLLE, A SEDE PIANA /M FILETTATURA  
 EINLEGTEIL, FLACH DIHTEND /M GEWINDE





Dim. mm	velikost	koda	l	s			
15	1/2"Č	KA12890002	39,5	27	370	10	0,072
15	1/2"P	KA12895002	39,5	27	370	10	0,076
20	3/4"Č	KA12890003	43,5	32	240	10	0,108
20	3/4"P	KA12895003	43,5	32	240	10	0,113
25	1"Č	KA12890004	48,5	38	150	10	0,152
25	1"P	KA12895004	48,5	38	150	10	0,160
32	1 1/4"Č	KA12890005	55,0	47	100		0,300
32	1 1/4"P	KA12895005	55,0	47	100		0,315
40	1 1/2"Č	KA12890006	57,0	53	70		0,380
40	1 1/2"P	KA12895006	57,0	53	70		0,398
50	2"Č	KA12890007	64,0	66	35		0,490
50	2"P	KA12895007	64,0	66	35		0,500

**ART.372**

VLOŽNI DEL, PLOŠČATO TESNENJE  
 UNION END, FLAT SEAT  
 PEZZO FOLLE, A SEDE PIANA  
 EINLEGTEIL MIT FLACH DIHTEND



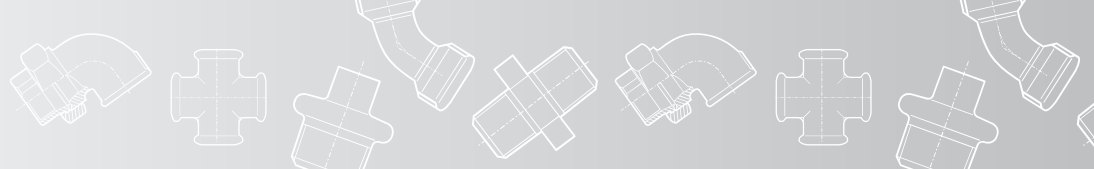

Dim. mm	velikost	koda	l	s			
15	1/2"Č	KA12870003	22,5	27	460	10	0,057
15	1/2"P	KA12875003	22,5	27	460	10	0,060
20	3/4"Č	KA12870004	24,0	32	400	10	0,070
20	3/4"P	KA12875004	24,0	32	400	10	0,074
25	1"Č	KA12870005	27,5	38	240		0,090
25	1"P	KA12875005	27,5	38	240		0,095
32	1 1/4"Č	KA12870006	30,5	47	120		0,160
32	1 1/4"P	KA12875006	30,5	47	120		0,168
40	1 1/2"Č	KA12870007	32,5	53	90		0,202
40	1 1/2"P	KA12875007	32,5	53	90		0,212
50	2"Č	KA12870008	36,5	66	50		0,360
50	2"P	KA12875008	36,5	66	50		0,378
65	2 1/2"Č	KA12870009	40,0	85	25		0,575
65	2 1/2"P	KA12875009	40,0	85	25		0,599
80	3"Č	KA12870010	44,0	97	20		0,720
80	3"P	KA12875010	44,0	97	20		0,740



**ART.374**  
ISO P1

**MATICA PRIVIJALA**  
**UNION NUT**  
**DADO**  
**ÜBERWURFMUTTER**



Dim. mm	velikost	koda	navoj	l	s			
15	1/2"Č	KA12860003	G11/8"	19	46	240	10	0,107
15	1/2"P	KA12865003	G11/8"	19	46	240	10	0,112
20	3/4"Č	KA12860004	G11/4"	20	50	200	10	0,127
20	3/4"P	KA12865004	G11/4"	20	50	200	10	0,133
25	1"Č	KA12860005	G11/2"	22	55	160	10	0,143
25	1"P	KA12865005	G11/2"	22	55	160	10	0,150
32	1 1/4"Č	KA12860006	G2"	24	70	80		0,268
32	1 1/4"P	KA12865006	G2"	24	70	80		0,275
40	1 1/2"Č	KA12860007	G2 1/4"	25	75	70		0,286
40	1 1/2"P	KA12865007	G2 1/4"	25	75	70		0,295
50	2"Č	KA12860008	G2 3/4"	27	90	50		0,361
50	2"P	KA12865008	G2 3/4"	27	90	50		0,374
65	2 1/2"Č	KA12860009	G3 1/2"	30	110	26		0,557
65	2 1/2"P	KA12865009	G3 1/2"	30	110	26		0,586
80	3"Č	KA12860010	G4"	31	129	18		1,030
80	3"P	KA12865010	G4"	31	129	18		1,076

**ART.471**

**ZIDNO KOLENO**  
**BRACKET ELBOW**  
**GOMITO PER SOFFITO**  
**DECKENWINKEL**

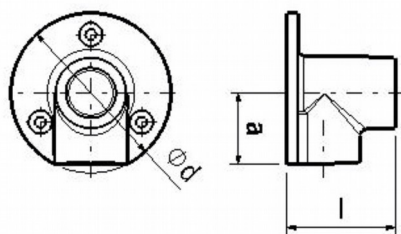

Dim. mm	velikost	koda	a	d	l			
15	1/2"Č	KA10250103	28	65	42	110	10	0,209
15	1/2"P	KA10255103	28	65	42	110	10	0,219
20	3/4"Č	KA10250104	33	70	50	70	10	0,274
20	3/4"P	KA10255104	33	70	50	70	10	0,288



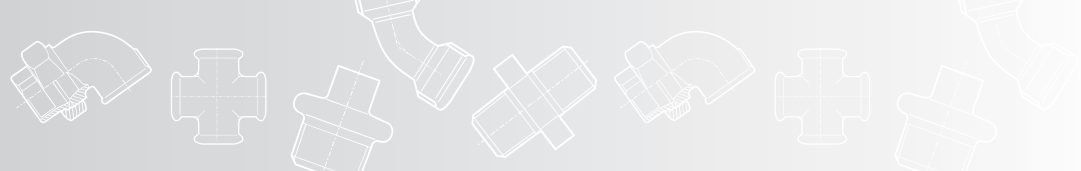

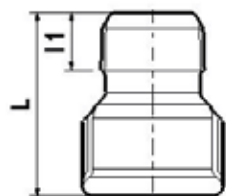

**ART.529a**  
**ISO M4**







**PODALJŠEK Z/N NAVOJ**  
**EXTENSION TUBE M/F THREAD**  
**PROLUNGAMENTO M/F FILETTATURA**  
**VERLAINGERUNG M/F GEWINDE**

Dim. mm	velikost	koda	L	L1			
15	1/2"-43Č	KA10330103	43	13	300	10	0,075
15	1/2"-43P	KA10335103	43	13	300	10	0,078
20	3/4"-48Č	KA10330104	48	15	170	10	0,105
20	3/4"-48P	KA10335104	48	15	170	10	0,110
25	1"-55Č	KA10330105	55	17	110	10	0,168
25	1"-55P	KA10335105	55	17	110	10	0,175

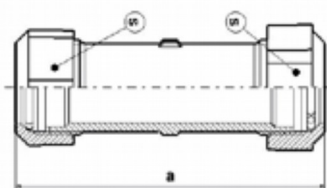
**ART.620**

**DVOJNI HITRO SPOJNI FITING Z VZMETNIM OBROČEM**  
**DOUBLE FAST UNION WITH ELASTIC BAND**  
**DOPPIO BOCCHETTONE RAPIDO CON ANELLO ELASTICO**  
**DOPPEL SCHNELLE SCHELLE MIT GUMMIBAND**





Dim. mm	velikost		koda	a	s			
15	1/2"Č	/PLIN/	KA10230103	88	41	50	10	0,347
15	1/2"P	/PLIN/	KA10235103	88	41	50	10	0,358
20	3/4"Č	/PLIN/	KA10230104	96	46	40	10	0,440
20	3/4"P	/PLIN/	KA10235104	96	46	40	10	0,454
25	1"Č	/PLIN/	KA10230105	130	55	20	10	0,700
25	1"P	/PLIN/	KA10235105	130	55	20	10	0,733

**ART.621**

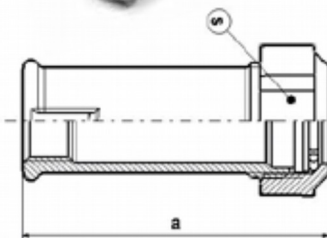
**HITRO SPOJNI FITING Z VZMETNIM OBROČEM**  
**FAST UNION WITH ELASTIC BAND**  
**BOCCHETTONE RAPIDO CON ANELLO ELASTICO**  
**SCHNELLE SCHELLE MIT GUMMIBAND**

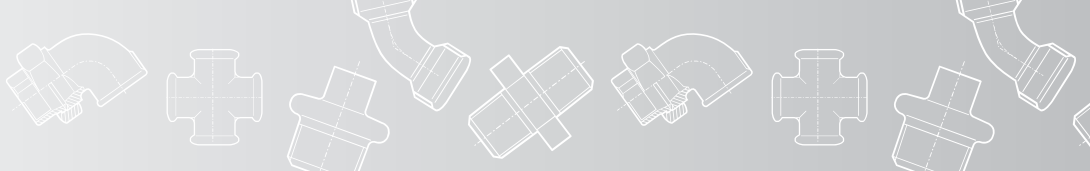

Dim. mm	velikost		koda	a	s			
15	1/2"Č	/PLIN/	KA10240103	88	41	70	10	0,261
15	1/2"P	/PLIN/	KA10245103	88	41	70	10	0,287
20	3/4"Č	/PLIN/	KA10240104	96	46	50	10	0,337
20	3/4"P	/PLIN/	KA10245104	96	46	50	10	0,375
25	1"Č	/PLIN/	KA10240105	120	55	30	10	0,480
25	1"P	/PLIN/	KA10245105	120	55	30	10	0,500

**ART.622**

DVOJNA SPOJKA, PREFABRIKAT  
 DOUBLE UNION, PREFABRICATE  
 DOPPIO BOCCHETTONE, PREFABBRICATI  
 DOPPEL VERSCHRAUBUNG, VORFABRIZIERT

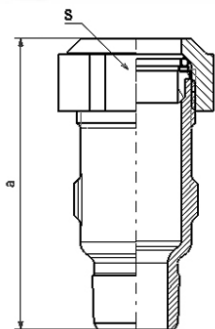

Dim. mm	velikost	koda	a	s			
20	3/4"Č	KA10280104	96	46	40	10	0,270
20	3/4"P	KA10285104	96	46	40	10	0,280
25	1"Č	KA10280105	106	55	20	10	0,430
25	1"P	KA10285105	106	55	20	10	0,440

**ART.372-374**

KOMPLET ZA ČRPALKO  
 KIT FOR THE PUMP  
 KIT PER LA POMPA  
 KIT FÜR DIE PUMPE

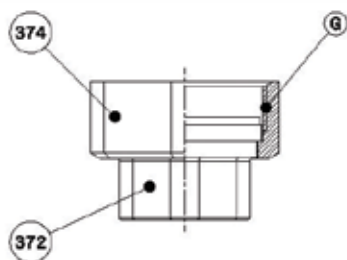



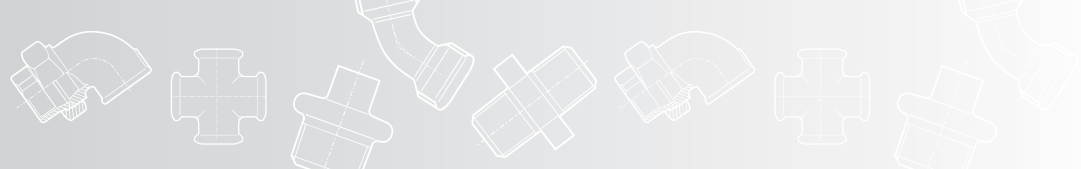

Dim. mm	velikost	koda	navoj v matici				
20	3/4"Č	KA10900224	G	1 1/4"	65	2	0,370
25	1"Č	KA10900225	G	1 1/2"	65	2	0,430
32	1 1/4"Č	KA10900226	G	2"	37	2	0,760



ART.820

DVOJNA SPOJKA, PREFABRIKAT  
 DOUBLE UNION, PREFABRICATE  
 DOPPIO BOCCHETTONE, PREFABBRICATI  
 DOPPEL VERSCHRAUBUNG, VORFABRIZIERT



Dim. mm	velikost	koda	a	s			
15	1/2"Č	KA10590103	88	41	50	10	0,347
15	1/2"P	KA10595103	88	41	50	10	0,358
20	3/4"Č	KA10590104	96	46	40	10	0,440
20	3/4"P	KA10595104	96	46	40	10	0,454
25	1"Č	KA10590105	106	55	20	10	0,659
25	1"P	KA10595105	106	55	20	10	0,680
32	1 1/4"Č	KA10590206	118	70			1,110
32	1 1/4"P	KA10595206	118	70			1,130
40	1 1/2"Č	KA10590207	122	75	15		1,210
40	1 1/2"P	KA10595207	122	75	15		1,230
50	2"Č	KA10590208	175	90	8		1,910
50	2"P	KA10595208	175	90	8		1,940
65	2 1/2"Č	KA10590209	190	110	4		3,280
65	2 1/2"P	KA10595209	190	110	4		3,330
80	3"Č	KA10590210	205	130	3		4,920
80	3"P	KA10595210	205	130	3		4,950

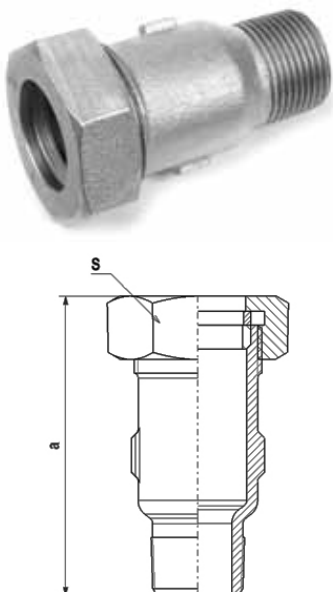

ART.822

SPOJKA, PREFABRIKAT ZUNAJNI NAVOJ  
 UNION, PREFABRICATE  
 BOCCHETTONE, PREFABBRICATI  
 VERSCHRAUBUNG, VORFABRIZIERT



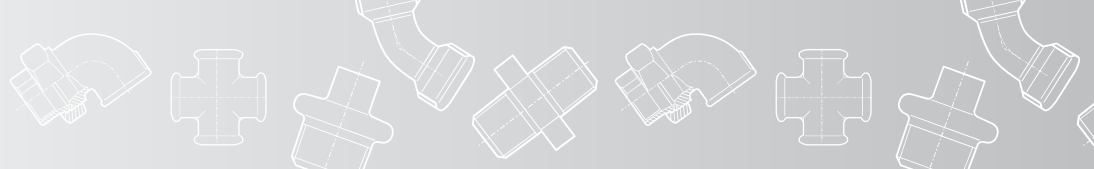
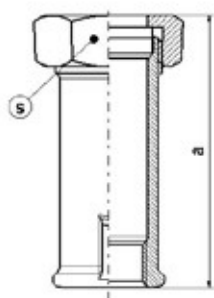

Dim. mm	velikost	koda	a	s			
20	3/4"Č	KA10850104	96	46	70	10	0,271
20	3/4"P	KA10855104	96	46	70	10	0,280
25	1"Č	KA10850105	106	55	40	10	0,397
25	1"P	KA10855105	106	55	40	10	0,410

**ART.821**
**SPOJKA, PREFABRIKAT  
UNION, PREFABRICATE  
BOCCHETTONE, PREFABBRICATI  
VERSCHRAUBUNG, VORFABRIZIERT**

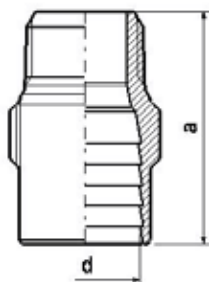
Dim. mm	velikost	koda	a	s			
15	1/2"Č	KA10580103	88	41	70	10	0,261
15	1/2"P	KA10585103	88	41	70	10	0,269
20	3/4"Č	KA10580104	96	46	50	10	0,337
20	3/4"P	KA10585104	96	46	50	10	0,347
25	1"Č	KA10580105	106	55	30	10	0,474
25	1"P	KA10585105	106	55	30	10	0,489
32	1 1/4"Č	KA10580206	118	70	20		0,801
32	1 1/4"P	KA10585206	118	70	20		0,826
40	1 1/2"Č	KA10580207	122	75	18		0,876
40	1 1/2"P	KA10585207	122	75	18		0,903
50	2"Č	KA10580208	155	90	10		1,441
50	2"P	KA10585208	155	90	10		1,486
65	2 1/2"Č	KA10580209	170	105	6		2,493
65	2 1/2"P	KA10585209	170	105	6		2,580
80	3"Č	KA10580210	170	130	4		3,254
80	3"P	KA10585210	170	130	4		3,355

**ART.900**
**SPOJKA ZA PVC CEVI  
NIPPLE FOR PLASTIC TUBES  
NIPPLI PER TUBI IN PLASTICA  
NIPPEL FUER PLASTIC ROEHRE**



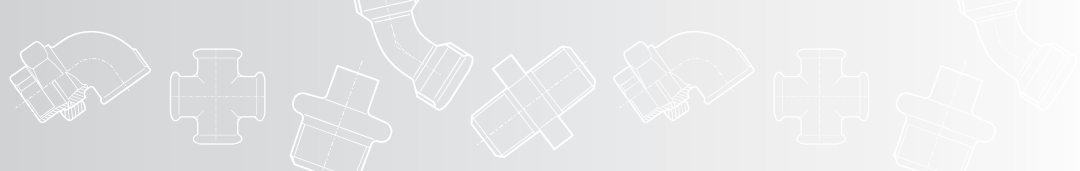

Dim. mm	velikost	koda	a	d			
15	1/2"Č	KA10600103	45	20	300	10	0,086
15	1/2"P	KA10605103	45	20	300	10	0,089
20	3/4"Č	KA10600104	55	25	180	10	0,130
20	3/4"P	KA10605104	55	25	180	10	0,127
25	1"Č	KA10600105	65	32	100	10	0,189
25	1"P	KA10605105	65	32	100	10	0,195
32	1 1/4"Č	KA10600206	75	40	70		0,298
32	1 1/4"P	KA10605206	75	40	70		0,307
40	1 1/2"Č	KA10600207	80	50	50		0,372
40	1 1/2"P	KA10605207	80	50	50		0,383
50	2"Č	KA10600208	100	63	25		0,669
50	2"P	KA10605208	100	63	25		0,690

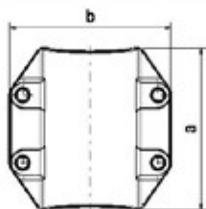

### ART.800





HITRA OBJEMKA  
REPARATION CLAMP  
COPRIBUCO  
REPARATURSCHELE

Dim. mm	velikost	koda	a	b			
20	3/4"Č	KA10910214	90	78	40		0,520
20	3/4"P	KA10915214	90	78	40		0,560

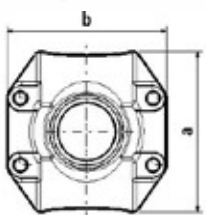
### ART.802



HIRA OBJEMKA Z NASTAVKOM  
INTAKE CLAMP  
COLLARE DI DERIVAZIONE  
REPARATURSCHELLE FÜR NEBENANCHLUSS

Dim. mm	velikost	koda	a	b			
20-15	3/4"-1/2"Č	KA10910204	90	78	40		0,570
20-15	3/4"-1/2"P	KA10915204	90	78	40		0,610

# КАТАЛОГ

## Фитинги чугунные ТИТАН

(Производство Словения)



**ООО Чугунторг**

+7 (495) 989-83-31

+7 (495) 668-08-14

[www.chuguntorg.ru](http://www.chuguntorg.ru)